

FAIR OAKS Precision Press Featuring High Speed, Precision, Safety, and Durability.

**FAIR
OAKS**

FAIR OAKS PRECISION MACHINERY CO., LTD. manufactures high-speed power presses ranging from 30 tons to 300 tons. Over the years, we have firmly established ourselves as a leading manufacturer in Taiwan. With a reputation for unyielding quality standard and professionalism, we provide our customers with advanced power presses with great value, which comes from rich features, high performance, sturdy construction, simple operation, easy maintenance, as well as responsive and quality service.

Our engineering team continues to produce innovations and breakthroughs for a more efficient and safer punching process. They also pay special attention to manufacturability and maintainability. Our manufacturing team receives expert training and adheres to the most rigorous quality assurance program. Our service team is very effective in helping our customers solve problems in time. All in all, we at Fair Oaks do our best to create value for you, our customer.

高將精機廠股份有限公司專業設計高速精密沖床，沖壓能力從 30 噸到 300 噸。歷經多年來的努力，高將公司已成為台灣精密沖床製造廠中之佼佼者。高將公司素以堅持高品質及專業技術，為業界所稱許；融合先進技術的高速精密沖床，以優異的性能，廣為國內外客戶所肯定。

高將公司擁有堅強的技術背景，因此我們能持續不斷的在技術上創新突破。而沖床的製造及檢驗，完全依據嚴格的品質標準。專業的品管人員，於製造過程中，施以嚴格檢驗，以確保每一部高將機器的優良品質。零組件進廠檢驗，製程及出廠前性能測試，只是整體品管保證的一部份而已，並且高將公司更能以卓越的技术能力，提供符合您需求的高速精密沖床。

Quality and Performance Create Great Value for you.

FAIR OAKS PRECISION MACHINERY CO., LTD. gives you a competitive edge by providing you with power presses with high speed, precision, and durability.

Our power presses are ruggedly constructed all the way through. The massive cast irons are stress relieved for deformation-free, long-term accuracy and stability. The frame structure is designed using Finite Element Analysis to achieve optimal structure strength and rigidity; it is highly resistant to vibration and has comprehensive safety guards. The microcomputer controller is very easy to learn and operate, reducing operator training to a minimum. Its self-diagnostic function and extensive interlocking control make operation safe and maintenance easy.

In a word, with our finely made high-speed power presses and our professional team, you can upgrade your production speed at a surprisingly low cost to further increase your profits.

高將精密沖床

融合速度、精密、安全、使用壽命長...

當今產業界需要高科技，提高產能及製品品質，以提昇其競爭力。高將精密沖床就是採用先進的沖壓技術，並秉持“高速、精密、使用壽命”而設計製造。機體結構更採用先進“電腦有限元素分析法”設計，達到最佳的強度及剛性和抗震能力。鑄件經過應力消除處理，確保長期操作不變形高精度及穩定性。採用微電腦控制器，記憶容量大，並具故障偵測功能，維修方便。控制器易學易操作。高將精密沖床擁有許多卓越特出的性能，大幅提昇您的加工速度，為您創造利潤。



Computerized squ areness test
電腦偵測垂直度

Computerized analysis
電腦有限元素分析

COMPUTER CONTROLLER

User-Friendly... Powerful Function...

Easy-to-Use and Powerful Computer Controller

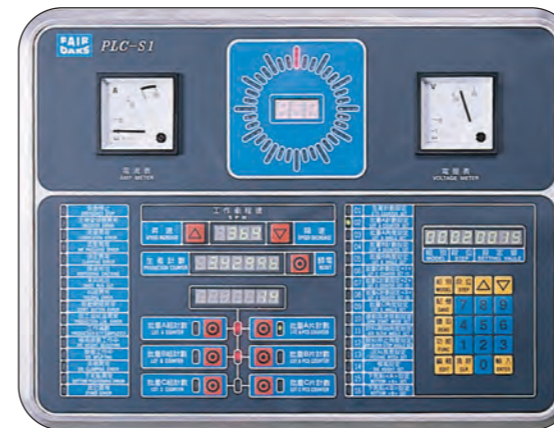

電腦控制器 操控簡易...功能強勁...

先進的電腦控制器，採用獨特開發的沖壓作業軟體。電腦功能強，記憶容量大。採用引導式參數設定，具故障顯示功能，使機械操作更為簡易。

- PLC-S1 控制器使用獨特開發沖壓專用軟體。
- 寸動定位角度，為多段式選擇。(90°, 135°, 165°, 180°, 195°, 270°, 0°)，經由選擇開關任意選定，方便校模，便利生產。
- 衝程數採用數位設定。
- 批量A, B 2組之疊層控制。
- 批量C具大小沖孔沖壓控制功能。
- 電腦可記憶 30 組加工資料。
- 引導式加工參數設定，操作方便。
- 具故障自我偵測功能及故障顯示，維修方便。
- 可擴充電腦功能。
- 電控迴路符合歐洲標準。

Our computer controller is designed specifically with the punching process in mind. Its ease of use and power are derived from a rich set of special functions, simple interface, mode setting in checklist form, error code display, and ample memory capacity. Specifically, the features include

- Fair Oaks' own PLC-S1 Controller with exclusive software.
- selections for stop angle in inching mode.
- Digital setting for stroke speeds.
- Lot "A", "B" control for auto-stacking of rotor & stator laminations.
- Special Lot "C" Control for punching rotor holes of different sizes.
- Sufficient memory to allow up to 30 sets of diesetting data.
- Convenient mode setting operation.
- Self-diagnostic function, error code display, and indicator lights.
- Extensive interlocking check for unreasonable settings to prevent safety problems and operation wastes.
- Extensible computer functions by custom order.
- Compliance with various electronic European standards.



GH-30

30 TONS

- 30 tons press capacity
- 600x450 mm bolster area
- 11kw motordrive

- 30噸沖壓力
- 台盤面積 600x450mm
- 主機馬達 11kw

- Axial bearing
軸向軸承
- Plunger guide
導柱
- Slide
滑座
- Extended guide
加長型導管
- Tie rod
機座螺樁
- Hydraulic locking device
油壓緊固裝置
- Base
腳座

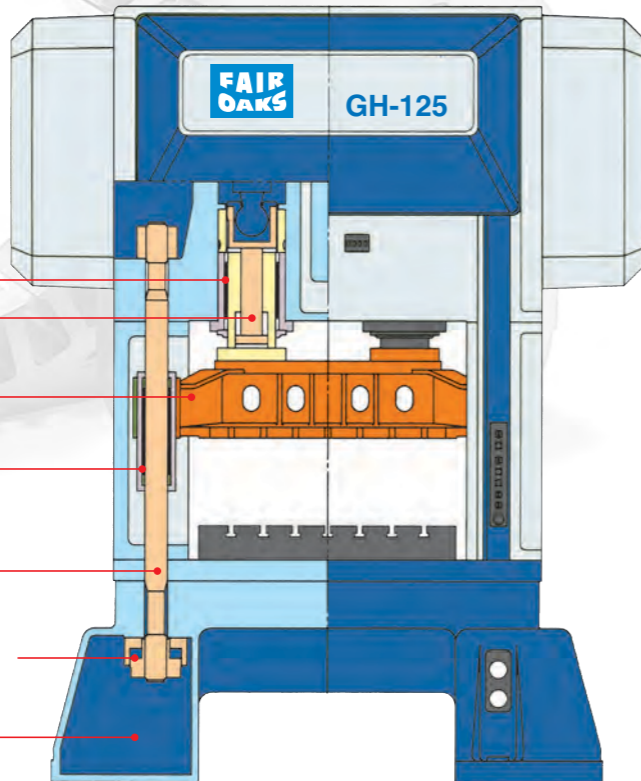

MACHINE FEATURES

FRAME

- Manufactured from high tensile cast iron, stress relieved for maximum rigidity and long term accuracy.
- The frame structure is designed by means of "Computerized finite element analysis". It provides optimum design for frame strength and strain.
- The frame is tightened by tie-rods, incorporating with hydraulic preload on structure for giving added rigidity.

MINIMUM VIBRATION, MINIMUM NOISE

- Outstanding dynamic balancing design reduces vibration and noise to a minimum.

PRECISION MAIN SHAFT

- Manufactured from Nickel Chrome Molybdenum alloy steel, hardened and precision ground.

HIGH POSITIONING ACCURACY

- Sensitive separated type clutch and brake assure high positioning accuracy and maximum safety guard.
- Plunger guides & slide guides utilize clearance free axial bearings.
- Preloaded tie-rods employed on slide guide for high rigidity, incorporating with extended guide for highly dynamic and static accuracy, service life of punch dies can be greatly upgraded.

LUBRICATION SYSTEM

- Employs a forced lubrication with cooling system to minimize thermal strain of machine frame, upgrade stamping quality and extend service life of the machine. The lubrication system is provided with a pressure detection device.

機械特性

機座

- 採用高強度鑄鐵，經應力消除，確保長期精度。
- 機構設計採用“電腦有限元素分析法”，因此對結構之強度及應變得以確保最佳的設計。
- 機架之連結，使用螺樁緊固並應用油壓動力，將機架結構預壓，大幅提升機架之剛性。

低振動、低噪音

- 優異的動態平衡設計，將振動與噪音降到最低，並可確保模具壽命。

精密主軸

- 曲軸採用鎳鎢鉻合金鋼，經過熱處理、研磨等精密加工。

定位精準

- 強力靈敏之分離式離合器及剎車器，確保定位精度，操作安全。
- 滑塊導柱：導桿採無間隙軸向軸承。
- 加長型導管，應用預壓螺樁之高剛性並配合加長型之導管，使其動、靜態精度超越特級精度。亦使沖壓模具壽命大幅提升。

潤滑系統

- 本機採用強制潤滑冷卻系統，除了降低機座熱應變，並確保沖壓工件品質，延長機械壽命。並附有壓力檢出功能。



Performance Curve 性能曲線圖

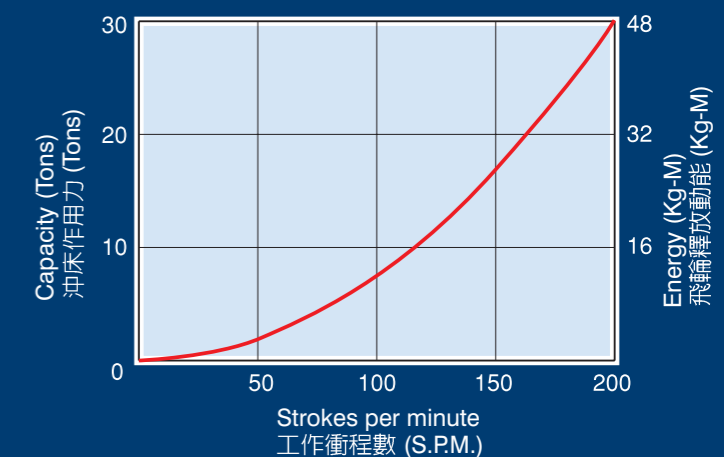
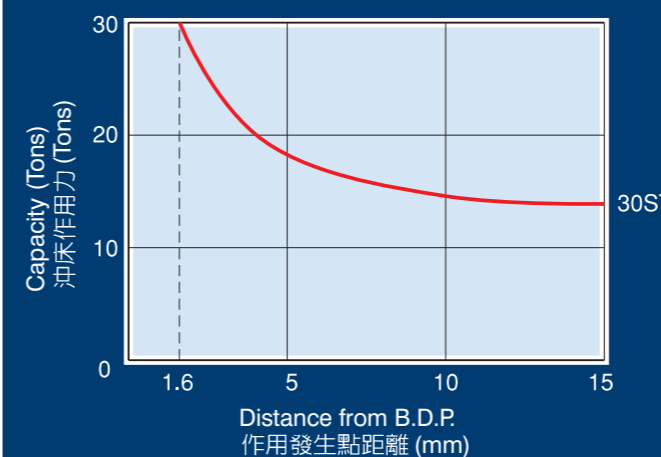

GH-45

45 TONS

- 45 tons press capacity
- 750x550 mm bolster area
- 15kw motordrive

- 45噸沖壓力
- 台盤面積 750x550mm
- 主機馬達 15kw



GH-60

60 TONS

- 60 tons press capacity
- 950x650 mm bolster area
- 19kw motordrive

- 60噸沖壓力
- 台盤面積 950x650mm
- 主機馬達 19kw



Performance Curve 性能曲線圖

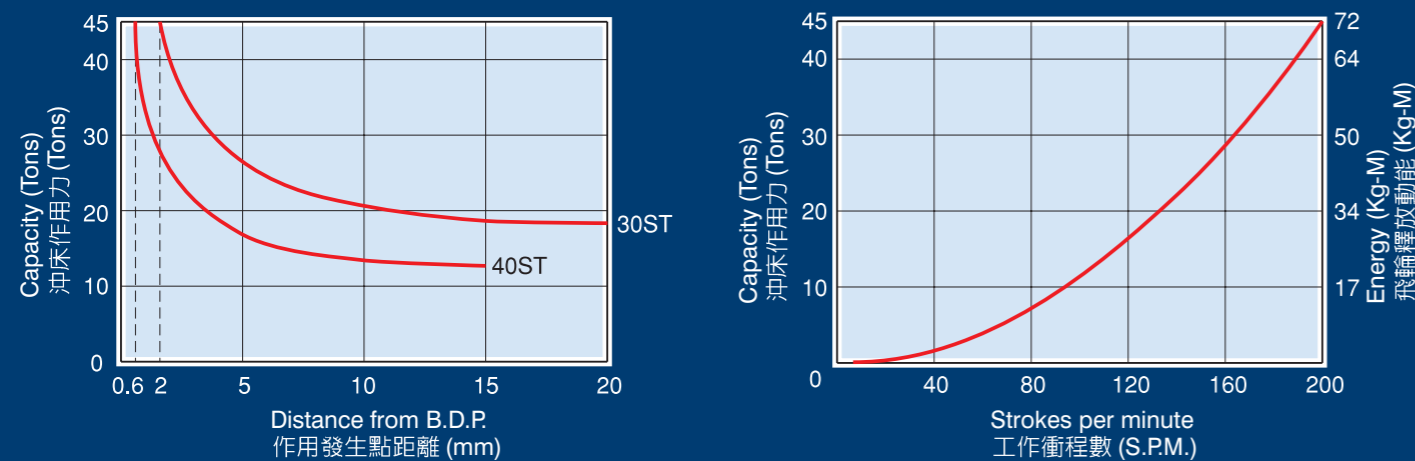

Performance Curve 性能曲線圖

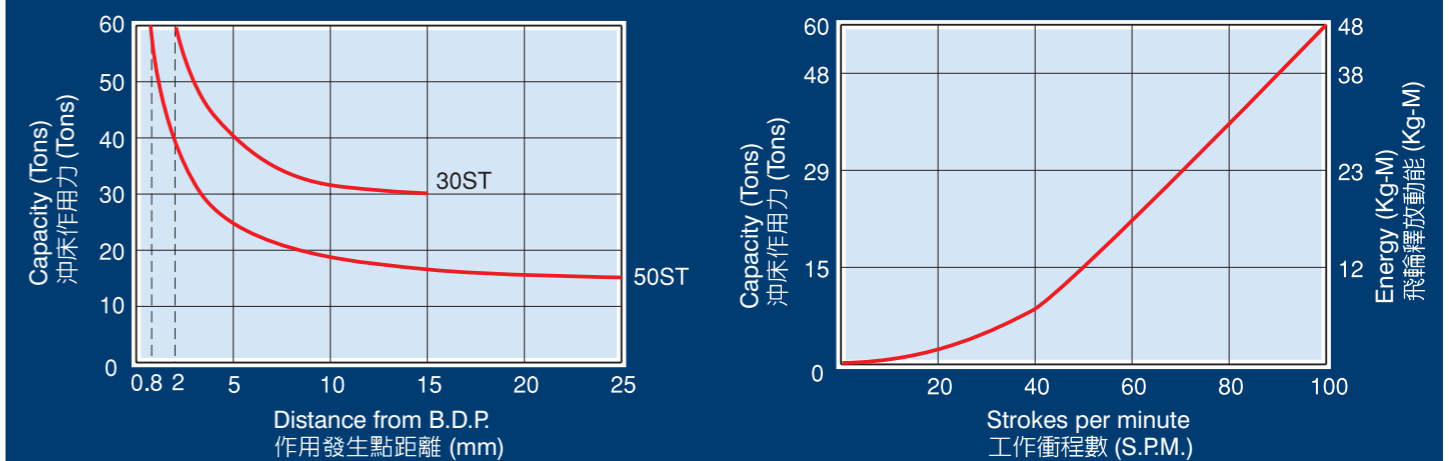

GH-80

80 TONS

- 80 tons press capacity
- 1100x750 mm bolster area
- 22kw motordrive

- 80噸沖壓力
- 台盤面積 1100x750mm
- 主機馬達 22kw



GH-125

125 TONS

- 125 tons press capacity
- 1200x850 mm bolster area
- 37kw motordrive

- 125噸沖壓力
- 台盤面積 1200x850mm
- 主機馬達 37kw



Performance Curve 性能曲線圖

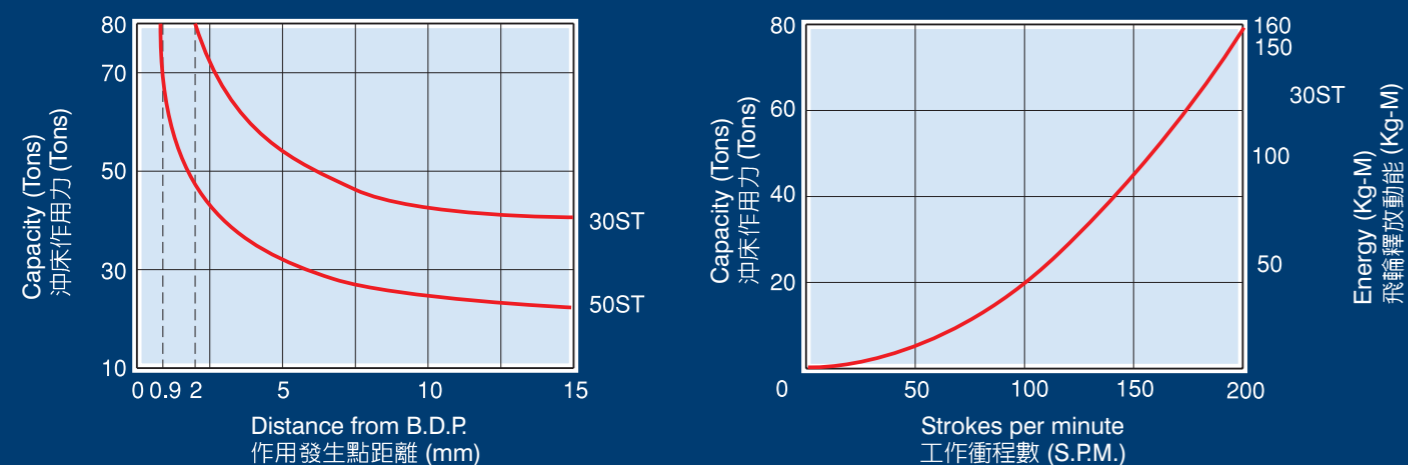

Performance Curve 性能曲線圖

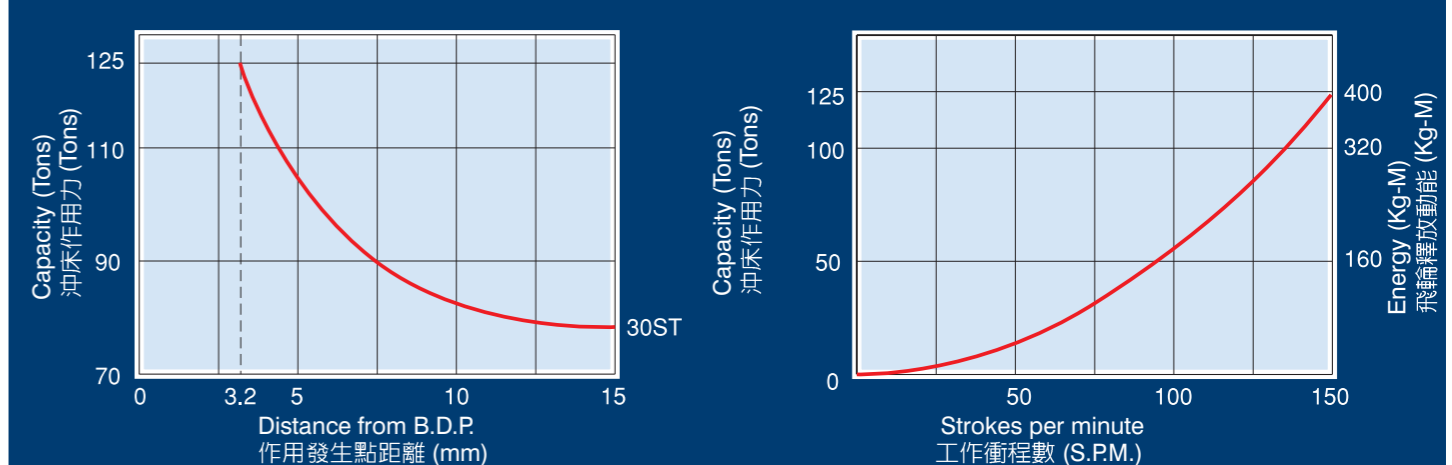

GH-220

220 TONS

- 220 tons press capacity
- 1700x950 mm bolster area
- 45kw motordrive

- 220噸沖壓力
- 台盤面積 1700x950mm
- 主機馬達 45kw



GH-300

300 TONS

- 300 tons press capacity
- 2000x1000 mm bolster area
- 45kw motordrive

- 300噸沖壓力
- 台盤面積 2000x1000mm
- 主機馬達 45kw



Performance Curve 性能曲線圖

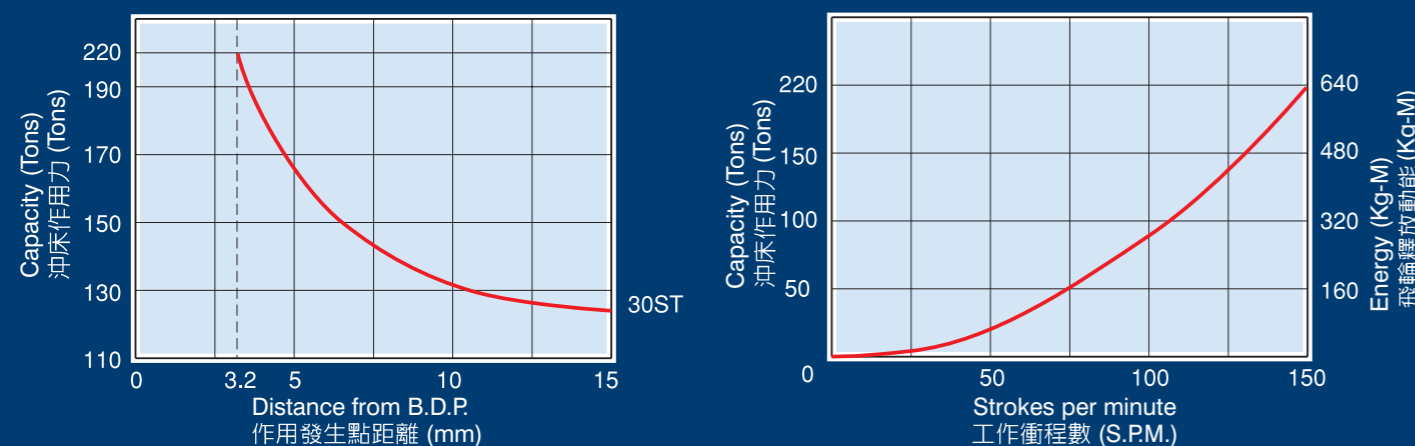

Performance Curve 性能曲線圖

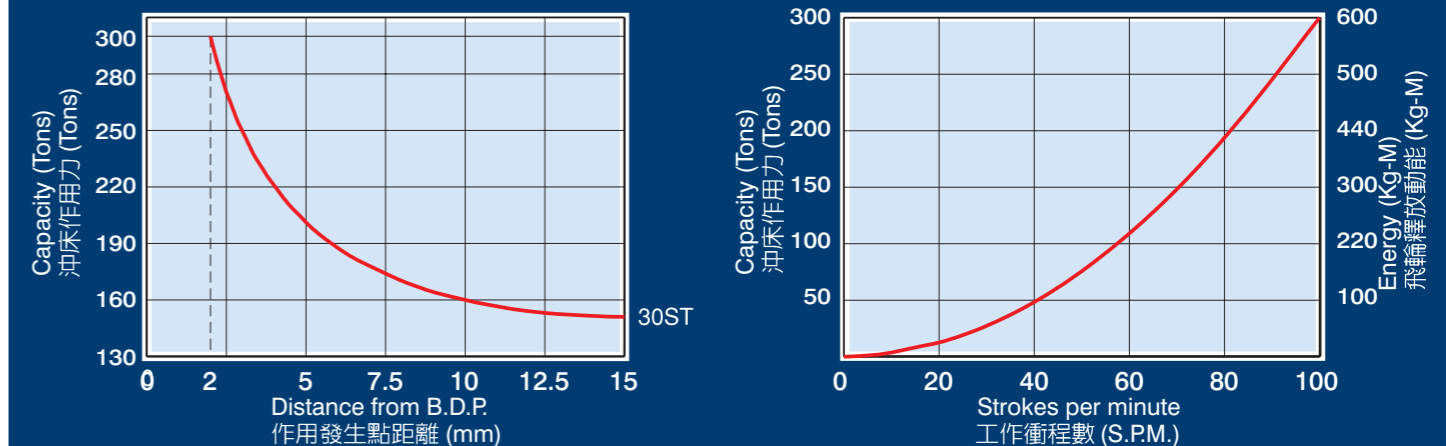



STANDARD ACCESSORIES

- Electric die height adjusting equipment.
- Digital die height indicator(0.01mm).
- Micro inching function.
- 30 sets memory for die setting data.
- Lot "A", "B", "C" control for auto-stacking.
- 2 sets of mis - feed detecting receptcle.
- Stroke stop setting 0° & 90° in continuous operation.
- Two way rotation main motor control.
- Hydraulic clamping unit for die height adjusting equipment.
- Lubricant cooling device.
- Separated clutch/brake.
- Independent electric control box.
- Tool box.
- Work light.

OPTIONAL EQUIPMENT

- Die height detector.
- Hydraulic die clamping device.
- Hydraulic die lifter & die arms.
- Hi-speed gear change feeder.
- Double head un - coiler.
- Leveler & "S" loop control.
- Anti-vibration mounts.
- F-3SC stamping controller.
- Inverter control for main motor.
- Two side sound proof safety door.

SPECIFICATIONS 主要規格

MODEL	機 型		GH-30	GH-45	GH-60	GH-80	GH-125	GH-220	GH-300
Nominal press capacity	公稱作用力	tons	30	45	60	80	125	220	300
Capacity occur point	能力發生點	mm	1.6	1.6	2.0	2.0	3.2	3.2	2
Stroke	衝程	mm	30	30	30	30	30	30	30
Strokes per minute	衝程數	s.p.m	200-900	200-800	200-800	200-700	150-700	150-600	100-450
Bolster area	工作台面積	mm	600x450	750x550	950x650	1100x750	1200x850	1700x950	2000x1000
Bolster hole	下料孔	mm	400x100	550x125	700x125	800x150	1000x200	1300x250	1800x300
Slide	滑座面積	mm	600x320	750x380	950x420	1100x500	1200x600	1700x700	2100x900
Die height adjustment	模高調整行程	mm	225-275	240-290	300-350	330-380	360-410	370-420	400-460
Adjusting motor	模高調整馬達	kw	0.4	0.4	0.4	0.75	0.75	1.5	1.5
Linear height	送料線高度	mm	120±15	135±15	160±15	175±15	195±15	200±15	210±15
Main motor	主機馬達	kw	11	15	19	22	37	45	45

- Specifications and design chrcteristics are subject to change without prior notice.
- 本公司對產品規格，設計特性均不斷研究改進，上述規格若有變更，恕不另行通知。

Optional Equipment 選購配備

F-3SC(單排、雙排、參排) STAMPING CONTROLLER 沖壓控制器 (1-ROW, 2-ROWS, 3-ROWS)

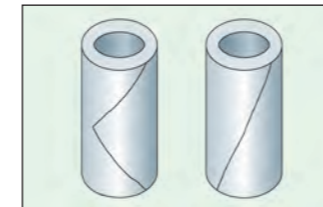

ROTOR SKEW CONTROL
馬達轉子斜槽控制



SHAFT HOLE SIZES CONTROL
馬達轉子中心孔階段控制

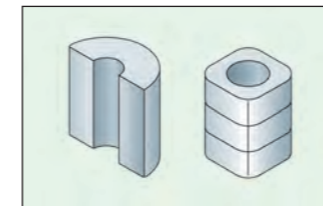

STACK CONTROL
馬達轉子及定子的疊層厚度控制



F-3SCS(單排、雙排) STAMPING CONTROLLER 沖壓控制器(觸控螢幕) (1-ROW, 2-ROWS) (TOUCHSCREEN)



ROTOR SKEW CONTROL

- Control skew angle precisely by stepping motor.
- Special V-type skew can be made.
- Have the compensatory function for gear back-lash.

SHAFT HOLE SIZES CONTROL

- 3 different sizes of shaft hole can be controlled.
- Stage's differential setting for synchronous counting.

ROTOR & STATOR STACK CONTROL

- Independent setting for rotor and stator.
- Key in number of lamination quantity only for setting the core thickness.

馬達轉子斜槽控制

及 V 型槽控制，並具有模具傳動件背隙補償功能。

馬達轉子中心孔階段控制

具有三階段的大小孔沖壓控制及計量與大小孔沖壓製程差數設定，得以自動調整同步性。

馬達轉子及定子的疊層厚度控制

可以獨立分開設定，於沖壓加工上更具彈性生產。於中大型馬達沖壓加工時，因需要更緊密之疊層，所以自扣深度可能穿透 2 片，因此本控制器得以配合模具作 2 片之計量功能。

QUICK DIE CHANGE EQUIPMENT
快速換模裝置

1. Hydraulic die lifter.
2. Die arms (Pre-rollers).
3. Hydraulic die claspers for upper die.
4. Hydraulic die claspers for lower die.

方便生產、降低勞力成本、達成快速產銷。

選擇組件：

1. 油壓舉模裝置。
2. 移模臂（移模座）。
3. 油壓上夾模。
4. 油壓下夾模。



GF-120 • 300 • 400 • 600

HI-SPEED FEEDER 高速送料機

Standard Equipments:

1. Material lubrication device. (With flow regulator)
2. Gear 4 pcs. (Teeth numbers as specified)
3. Extended material support.
4. Material end sensor. (DC24V NPN)
5. Pneumatic material clamping device.

附件：

1. 材料潤滑裝置。（附流量調整）
2. 齒輪 4 只。（客戶指定齒數）
3. 加長型托料架。
4. 末料檢出光電開關。（DC24V NPN）
5. 氣壓式材料夾持釋放裝置。

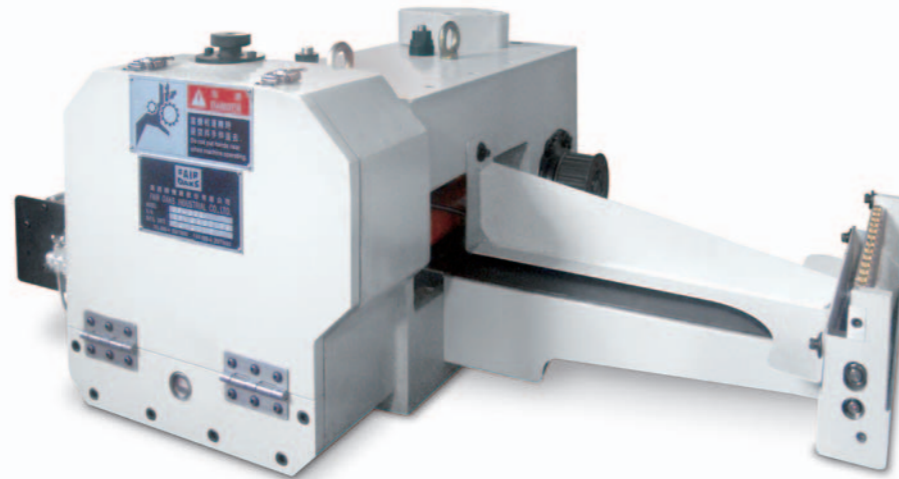

GEAR-CHANGE TYPE HIGH SPEED FEEDER 齒輪更換式高速送料機

P= Feed pitch (mm)

N= Index numbers

N1= 1st gear teeth number

N2= 2nd gear teeth number

N3= 3rd gear teeth number

N4= 4th gear teeth number

D= Feed roller diameter (mm)

P= 送料節距(mm)

N= 分割數

N1= 第1齒輪齒數

N2= 第2齒輪齒數

N3= 第3齒輪齒數

N4= 第4齒輪齒數

D= 送料滾輪直徑(mm)

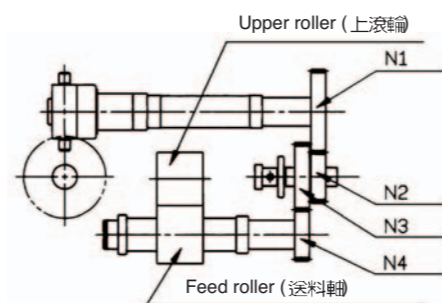

$$P = \frac{N1}{N2} \times \frac{N3}{N4} \times \frac{\pi D}{N}$$

GU-300 • 400 • 600

DOUBLE HEAD UNCOILER 雙頭油壓開捲機

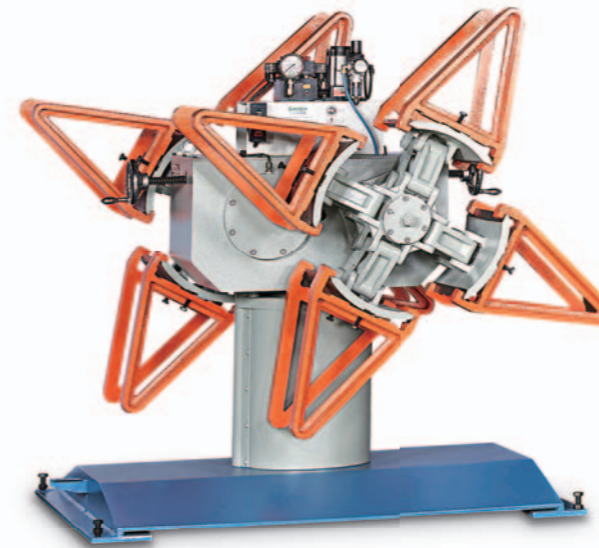

GS-300 • 400 • 600

LEVELER "S" LOOP CONTROL 整平出料機

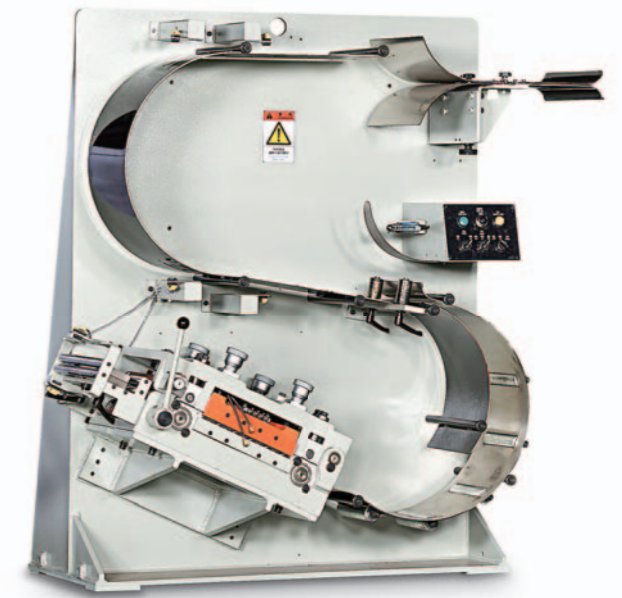

GF-120 • 300 • 400 • 600

HI-SPEED FEEDER 高速送料機

MODEL	機型		GF-120	GF-300	GF-400	GF-600
Thickness of material	材料厚度	mm	0.2~1.0	0.2~1.0	0.2~1.0	0.2~1.0
Width of materia	材料寬度	mm	30~120	50~300	50~400	78~600
Feed roller dia	送料滾輪直徑	mm	ø70	ø70	ø100	ø120
Feed length	送料長度	mm	15~250 / 4~90	15~300	10~350	10~578
Index numbers	分割數		4 / 12	4	4	3
Feed angle	送料角度		180°	180°	150°	180°
Release angle	鬆弛角度		135°~195°	135°~195°	110°~220°	110°~220°
Feed direction	送料方向		Left → right 左→右			

GU-300 • 400 • 600

DOUBLE HEAD UNCOILER 雙頭油壓開捲機

MODEL	機型		GU-300	GU-400	GU-600
Max. material width.	最大材料寬度	mm	300	400	600
Max. coil O.D.	最大材料外徑	mm	1200	1600	1600
Coil I.D.	卷料內徑	mm	508	508	508
Variation range (Min. /Max.)	擴張範圍	mm	450~530	450~530	450~530
Max. coil weight.	最大材料重量	kgf	1500 x 2	2500 x 2	3000 x 2

GS-300 • 400 • 600

LEVELER "S" LOOP CONTROL 整平出料機

MODEL	機型		GS-300	GS-400	GS-600
Driving motor	驅動馬達	kw	2.2	3.7	3.7
Material thickness	材料厚度	mm	0.2~1.0	0.2~1.0	0.2~1.0
Max. material width.	最大材料寬度	mm	50~300	50~400	50~600
Feed speed of leveller	整平機送料速度	m/min	1~68	1~72	1~74

Fair oaks machinery



Quality control system is staffed with professionals, and fully equipped with various sophisticated inspection to ensure that high standards are maintained throughout every step of manufacturing.

本公司具有完善的技術服務體系，並提供客戶售前的技術諮詢及售後的維修保養，得以確保機械性能的極致發揮。

- All specifications, dimensions and design characteristics shown in this catalogue are subject to change without notice.
- 本公司隨時進行研究改善的工作，因此本型錄內所規定尺寸及設計特性，得以變更，不另行通知。



FAIR OAKS PRECISION MACHINERY CO., LTD.

No.171, Xitou Rd., Shengang Dist., Taichung City 42953, Taiwan
TEL : +886-4-2563 2320
FAX : +886-4-2563 3133
URL : www.fairoaks-press.com.tw
E-mail : goal.jump@msa.hinet.net

高將精機廠股份有限公司

台灣 42953 台中市神岡區溪頭路 171 號
TEL : 886-4-2563 2320
FAX : 886-4-2563 3133
URL : www.fairoaks-press.com.tw
E-mail : goal.jump@msa.hinet.net

11.2018 / 1000 03-068/S Sunway 04-2322 7907

High Speed Precision Press

Featuring High Speed, Precision, Safety, and Durability.



FAIR OAKS PRECISION MACHINERY CO., LTD.